

ET42

Tracked Conventional Tail Excavators



**WACKER
NEUSON**
all it takes!



Innovative mini-excavator impresses with its power

Full steam ahead: The mini-excavator ET42 combines what is time-tested and proven with a large portion of innovation, thus becoming a master in the 4-ton class. It has the expected high lifting and excavation power as well as rapid work cycles. Thanks to the newest technologies, the emissions of the mini-excavator were reduced and the efficiency simultaneously increased, among other things. This is how, for example, the powerful engine of the ET42 fulfills the standards for exhaust emissions stage 5. The excavator is also impressive in terms of operator-friendliness. Work is no trouble at all thanks to the intuitive operating concept and flawless view of the working area.

- Performance is emphasized here: Six auxiliary control circuits, high lifting and excavation power and thus, rapid work cycles
- 3-point kinematics for more breakout force, insertion depth and dumping height
- Comfortable and fatigue-free joystick control thanks to Load Sensing Flow Sharing

ET42 Technical specifications

Operating data

Shipping weight	3,817 - 4,609 kg
Operating weight	4,032 - 4,824 kg
Biting force max. short dipper stick	20.8 kN
Breakout force max. bucket edge (ISO 6015), fix mounted + high power bucket	43.8 kN
Digging depth max.	3,544 mm
L x W x H	5,146 x 1,750 x 2,494 mm

Engine / Motor

Engine / Motor manufacturer	Perkins diesel engine
Engine / Motor type	403J-E17T
Engine / Motor	Water-cooled 3-cylinder turbo engine
Emission standards stage	5
Displacement	1,662 cm ³
RPM / speed	2,000 rpm
Engine performance	32.5 kW
Battery	77 Ah
Fuel tank capacity	80 l
Voltage	12 V

Hydraulic system

Duty pump	1 axial piston pump
Flow rate Max.	90 l/min
Operating pressure for working and driving hydraulics	245 bar
Operating pressure Slewing gear	206 bar
RPM / speed Revolving superstructure	9 rpm

Undercarriage

Travel speed Max.	4.8 km/h
Chain width	350 mm
Ground clearance	300 mm

Dozer Blade

Width	1,750 mm
Height	345 mm
Stroke Above subgrade	420 mm
Stroke Below subgrade	520 mm

Sound level

Sound level (LwA)	97 dB(A)
Cabin - specified sound pressure level LpA	76 dB(A)

ET42 Dimensions

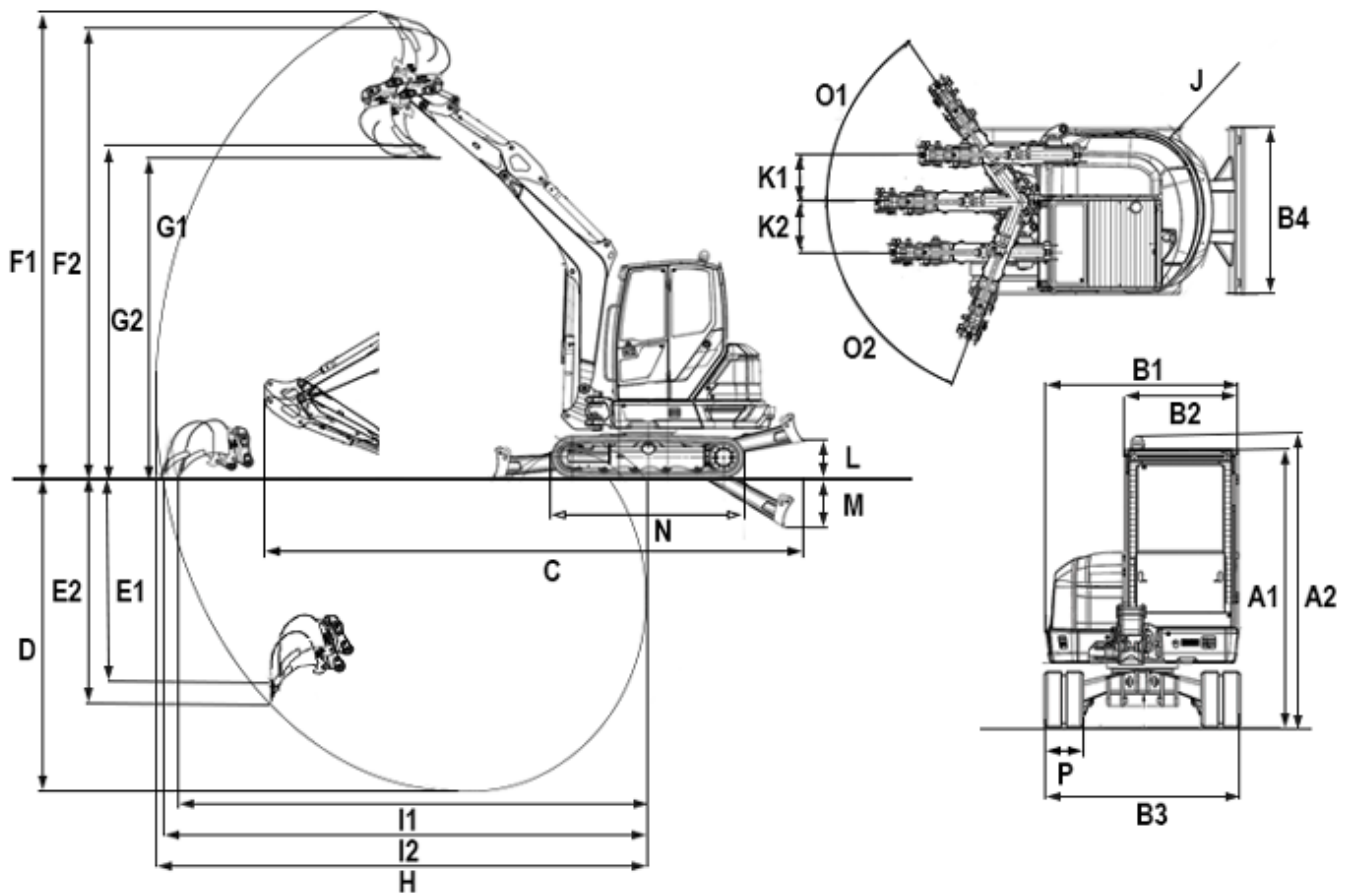

A1	Height	2,494 mm
A2	Height With rotating beacon	2,608 mm
B1	Width Revolving superstructure	1,720 mm
B2	Width Cab	980 mm
B3	Width Travel gear	1,750 mm
B4	Width Dozer blade	1,750 mm
C	Transport length Max., short dipper stick	5,146 mm
C	Transport length Max., long dipper stick	5,152 mm
D	Digging depth max. Short shovel arm	3,344 mm
D	Digging depth max. Long dipper stick	3,544 mm
E1	Insertion depth Max., short dipper stick	2,114 mm
E2	Insertion depth Max., long dipper stick	2,293 mm
F1	Insertion height Max., short shovel arm	5,210 mm
F2	Insertion height Max., long shovel arm	5,340 mm
G1	Dump height max. Short dipper stick	3,573 mm
G2	Dump height max. Long shovel arm	3,703 mm
H1	Digging radius max. Short shovel arm	5,489 mm
H2	Digging radius max. Long shovel arm	5,678 mm
I1	Range Max., short shovel arm	5,376 mm
I2	Range Max., long dipper stick	5,570 mm

J	Rear swivel radius	1,335 mm
K1	Arm displacement Max. (to center of bucket right side)	493 mm
K2	Arm displacement Max. (to center of bucket left side)	532 mm
L	Lift height Max. (dozer blade above subgrade)	418 mm
M	Scraping depth Max. (dozer blade below subgrade)	563 mm
N	Length Travel gear	2,198 mm
O1	Turning angle Max. (arm system to the right)	55 °
O2	Turning angle Max. (arm system to the left)	70 °
P	Chain width	350 mm
Q	Boom slewing radius Middle	2,175 mm
Q	Boom slewing radius Right	2,061 mm
Q	Boom slewing radius Left	1,820 mm

* Data valid for machines with and without option vds

Please note: that product availability can vary from country to country. It is possible that information / products may not be available in your country. More detailed information on engine power can be found in the operator's manual; the stated power may vary due to specific operating conditions. Subject to alterations and errors excepted. Applicable also to illustrations.

Copyright © 2021 Wacker Neuson SE.